



s/f: 28.4 total

Plt. # 10936 - 3295 Post Rd

Scale: 3/4" = 1'

*VECTOR file required for production.

JOB: 2023
The Social House
LOCATION: - Suite x
3295 Post Rd., Warwick, RI

FILE:
C-proposed
DATE:
2/15/23

REVISED:
8/7/23

PROJECT MANAGER:
George D.
DESIGNED BY:
JSR

CLIENT APPROVAL

Date _____

NOTICE TO CLIENT

This drawing is a representation of how your signage will appear. By signing this drawing you are accepting the design as it is presented on this page.



221 Jefferson boulevard & Warwick, RI
t 401.738.6155 f 401.738.8244

This design proposal is the property of AA Thrifty Sign & Awning. It is furnished with the expressed understanding that it will not be copied in any manner without written permission.

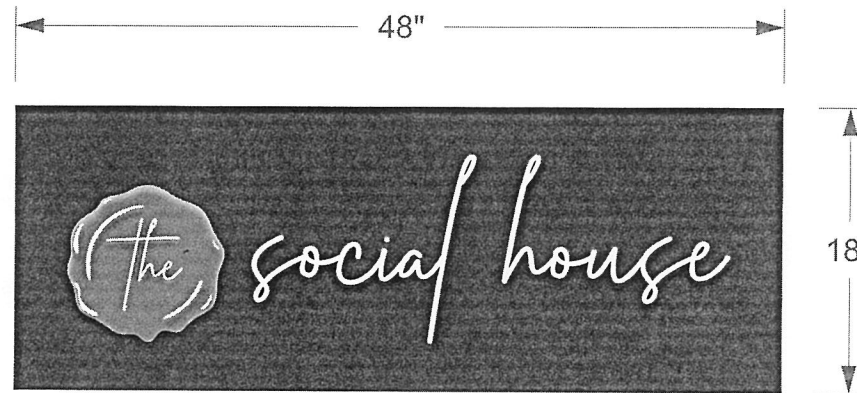

OPTION 3

s/f: 6

DESCRIPTION:

- Double face hanging sign
- 3/4" PVC painted black with digitally printed logo and HP white vinyl graphics
- Hung from existing bracket

Scale: 3/4" = 1'

*VECTOR file required for production.

JOB: 2023
The Social House

LOCATION: - Suite x
3295 Post Rd., Warwick, RI

FILE:
C-blade

DATE:
2/15/23

REVISED:
8/7/23

PROJECT MANAGER:
George D.

DESIGNED BY:
JSR

CLIENT APPROVAL

_____ Date _____

NOTICE TO CLIENT

This drawing is a representation of how your signage will appear. By signing this drawing you are accepting the design as it is presented on this page.



221 Jefferson Boulevard & Warwick, RI
v / 401.738.8055 / f / 401.738.8244

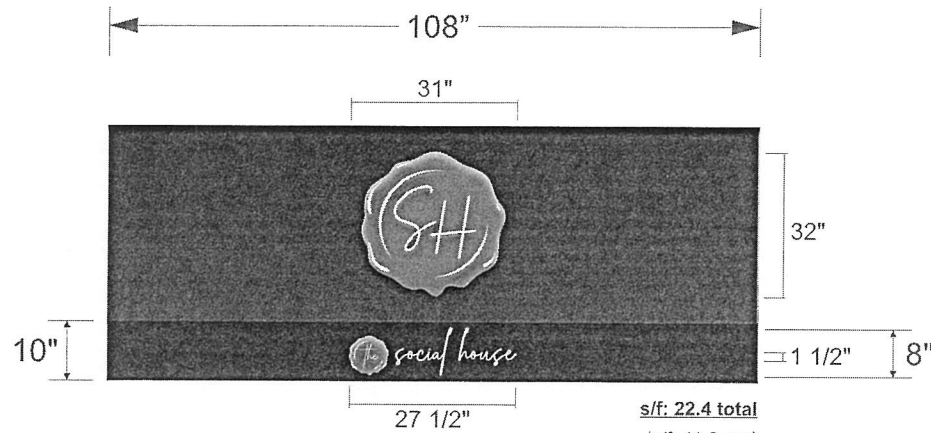

s/f: 22.4 total
 (s/f: 11.2 per)
 Graphics 20% of total s/f

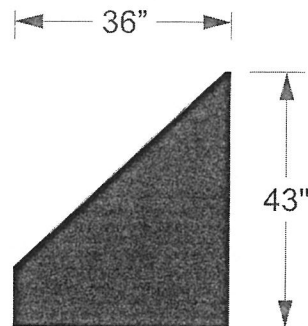
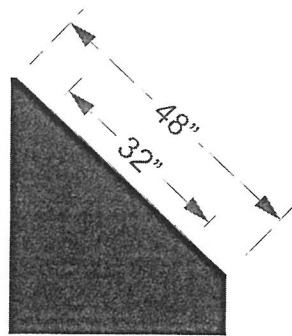

DESCRIPTION: Qty 2

- Awning recover in black fabric
- Add 10" rigid valance
- Custom painted red and white graphics

Method of attachment (not to scale)

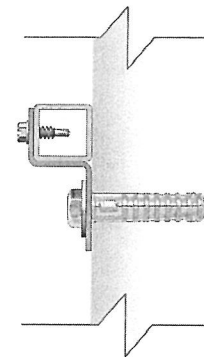

Z-Clips with 1/2" Tech screw as needed for fastening to aluminum frame

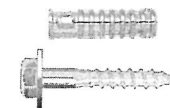

3/8"x3" lag/shield to Brick/CMU wall

Scale: 3/8" = 1'

*VECTOR file required for production.

JOB: 2023
 The Social House
 LOCATION: - Suite x
 3295 Post Rd., Warwick, RI

FILE:
 C-awnings
 DATE:
 2/15/23

REVISED:
 8/25/23

PROJECT MANAGER:
 George D.
 DESIGNED BY:
 JSR

CLIENT APPROVAL

Date _____

NOTICE TO CLIENT

This drawing is a representation of how your signage will appear. By signing this drawing you are accepting the design as it is presented on this page.

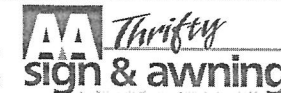

221 Jefferson Boulevard • Warwick, RI

V / 401.738.6055 T / 401.738.8244